

Lecture 7

Advances in mass spectrometry

Mass spectrometry as an important tool in chemical discovery

Clusters

Fullerenes, rings

Gas phase chemistry

Reaction dynamics

Atmospheric chemistry

Environmental sciences

Biology

Chemical mass spectrometry

Analytical tool

Process of discovery

kDa range, femtomole quantities, newer methods, instrumentation

Miniaturisation, adaptation, absorption of other tools into mass spectrometry

Spectroscopy of the largest to the least

From near to far

Molecules to materials

Atom to biomolecules

Range is infinite

Mass spectrometry: Then

Figure 30.1 Directional focusing of an ion beam that is at right angles to a magnetic sector.

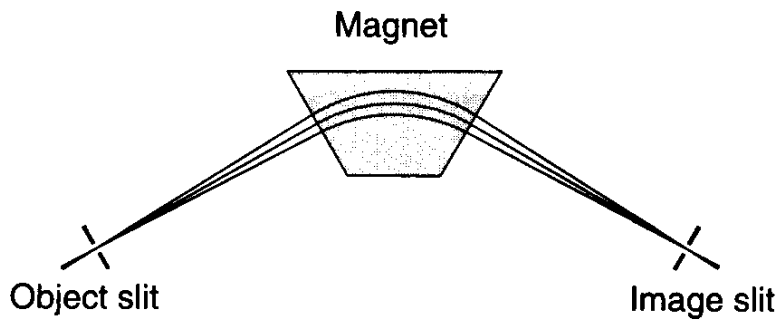
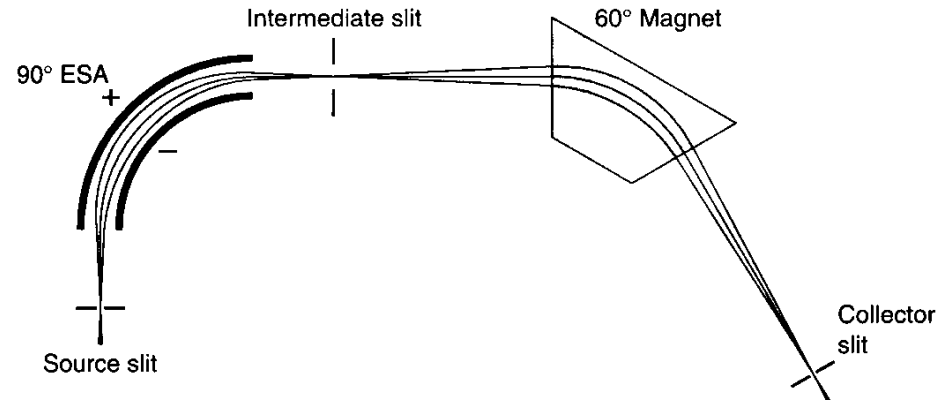

Figure 30.4 Double-focusing mass spectrometer of the Nier-Johnson type.



Analysis methods

Electric sector $mv^2/r = zE$, electric sector is a mass filter for daughter ions
E is the field strength in V/m

Magnetic sector $mv^2/r = zvB$ or $mv/z = Br$, $m/z = B^2r^2/2V$, mass to charge ratio of the ion is a function of both accelerating voltage and magnetic field.

Quadrupole DC, V_1 RF $V_0 \cos t$, opposite rods of different polarity
Force on the ions,
 $F_y = ma_y = z(V_1 + V_0 \cos t)2y/r_0^2$
 $F_z = ma_z = -z(V_1 + V_0 \cos t)2z/r_0^2$
 $F_x = ma_x = 0$ x is along the axis of the quadrupole, ion motion is in the zy plane.

Time of flight $t = L/v$ or $t = Lm^{1/2} / (2zV)^{1/2}$

Time taken for the ion for a complete revolution inside the cell, $t = 2r/v$
 $t = 2(m/zB)$, time is inversely proportional to cyclotron frequency, $f_c = 1/t = Bz/2m$, $m/z = B/2f_c$.

ICR Each ion has a characteristic f_c . Upon application of rf voltage, parallel to the field, with frequency f_c , ions with that f_c absorb energy, increase r and finally reach the detector plates. In FT ICR a broad band rf pulse is given exciting all ions and image current as function of time.

Figure 30.6 FTMS cubic cell.

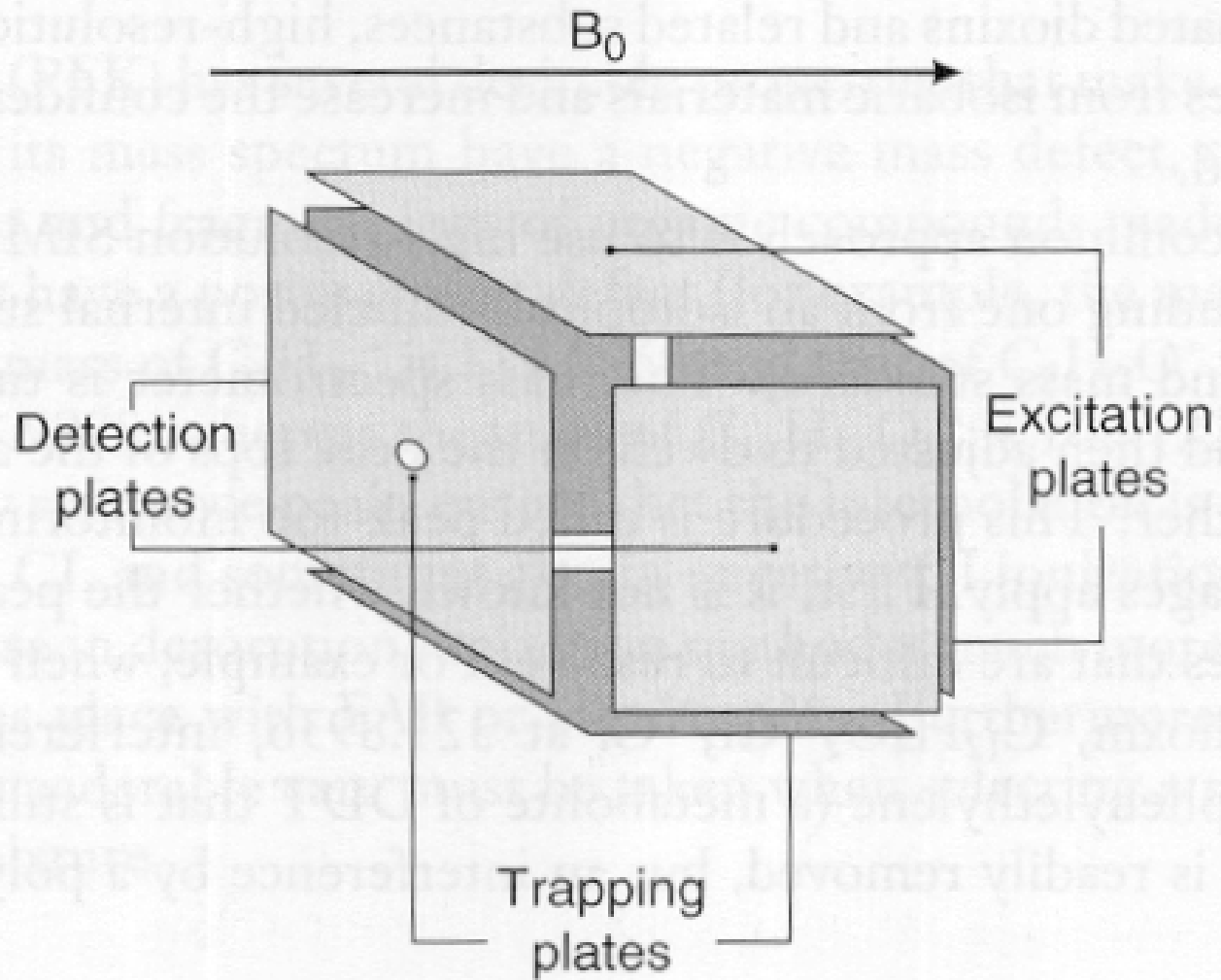
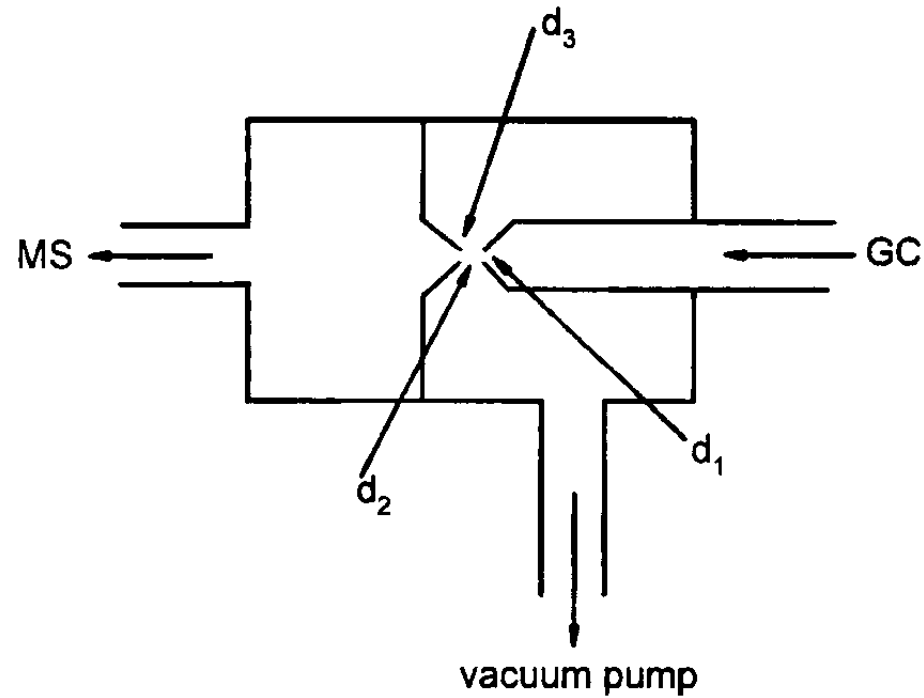
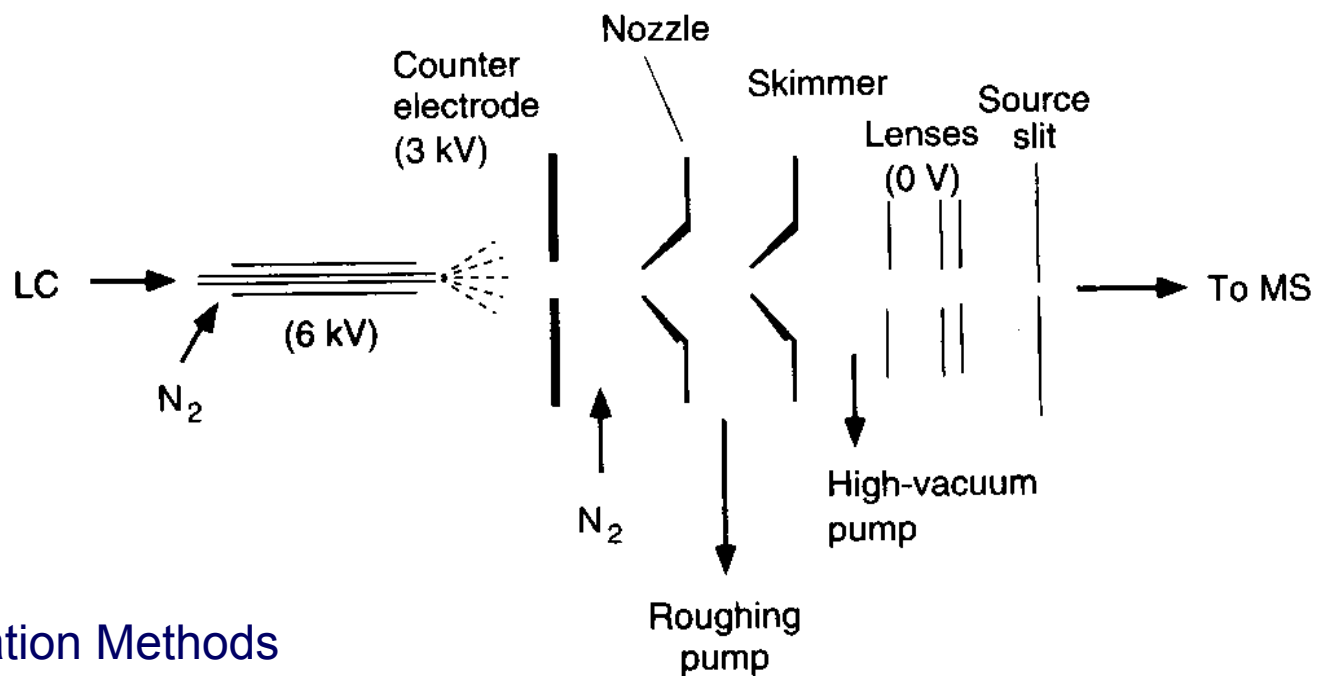

Figure 31.1 The jet separator, a device for interfacing a packed column GC with an MS. The three distances are typically d_1 , 100 μm ; d_2 , 300 μm ; and d_3 , 240 μm .



GC Interface

Figure 33.2 Schematic of a typical ESI source.



New Ionization Methods

Figure 32.2 The FAB or LSIMS sample insertion probe, inserted into the ion source of a magnetic mass spectrometer. The sample is bombarded by either Xe^0 atoms or Cs^+ ions.

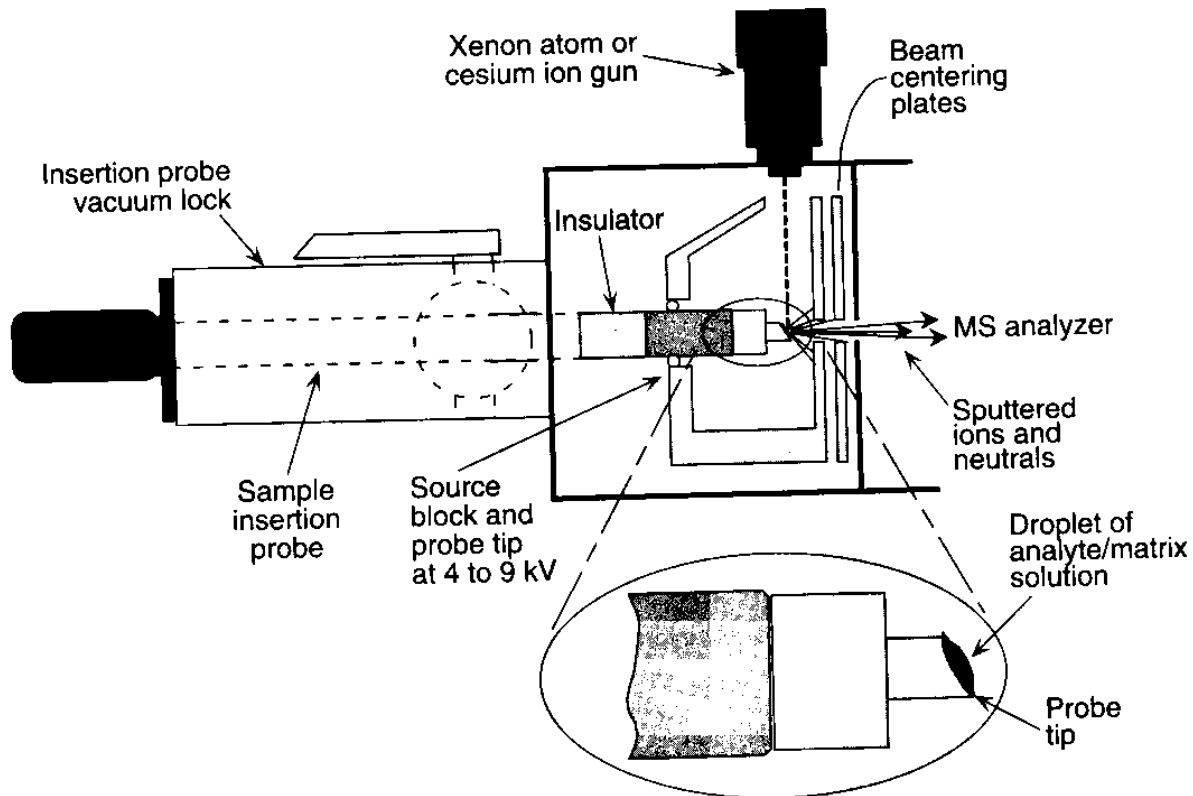

32.3 FAB bombardment and sputtering processes viewed at the molecular level.

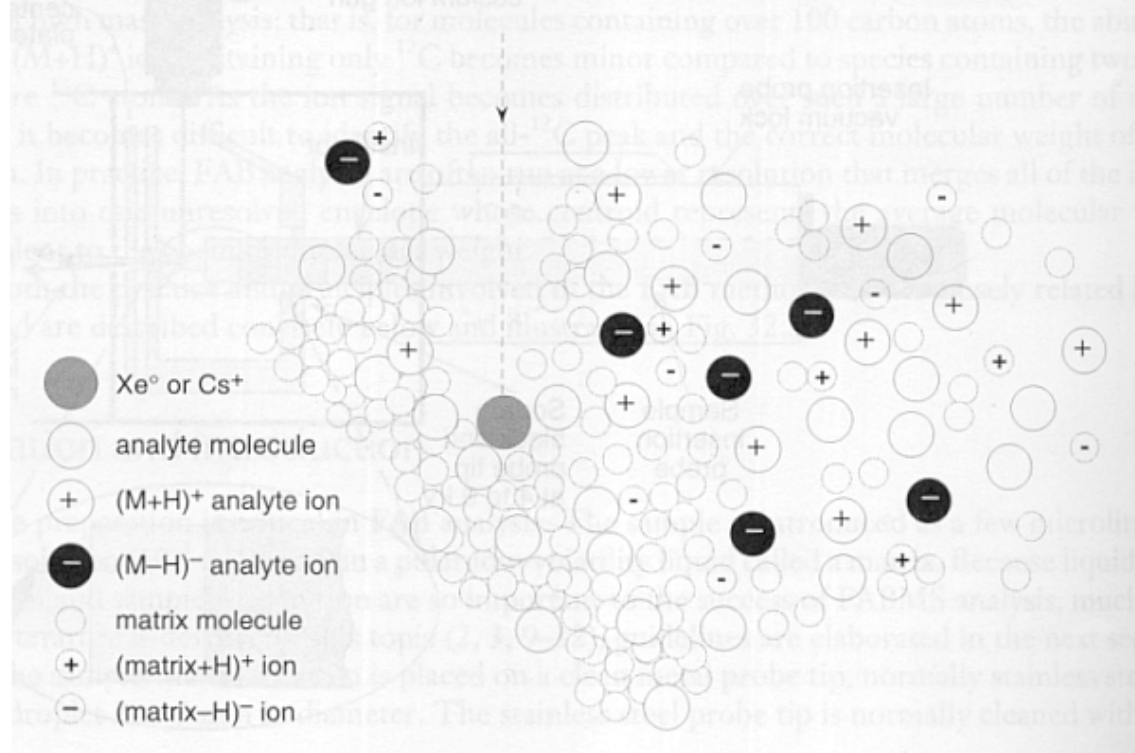

Soft methods

Mass spectrometry and modern advances

New ion activation tools

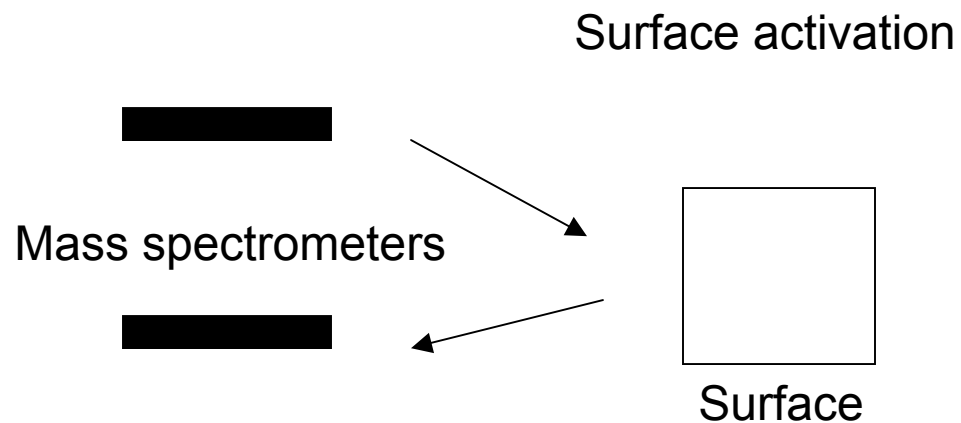
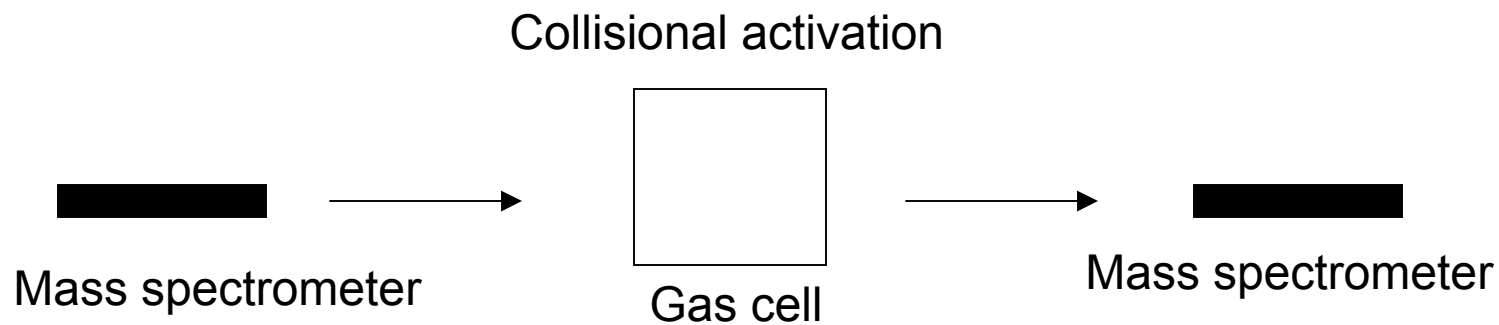

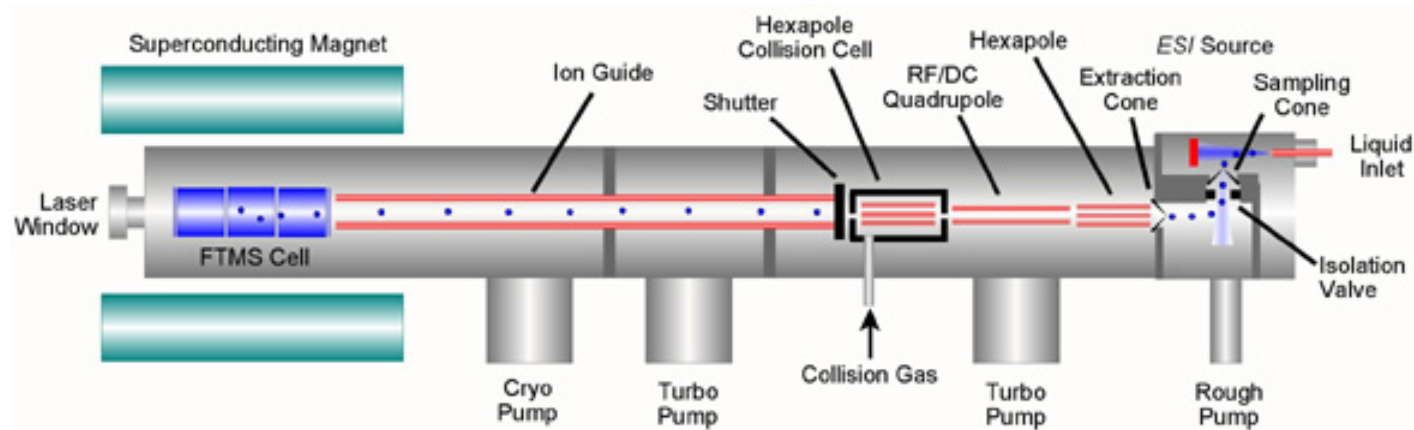

One hybrid instrument

Figure 34.1 The mass spectrum of cascade polymer 48-cascade:benzene[3-1,3,5]:(5-ethynyl-1,3-phenylene):5-ethynyl-1,3-di(tert-butyl)benzene, containing 94 phenylacetylene monomer units (D-94) analyzed by UV MALDI-TOF. The measured mass accuracy is 40 ppm using the PEG as an internal mass standard. The spectral resolution of the molecular ion is 1100.

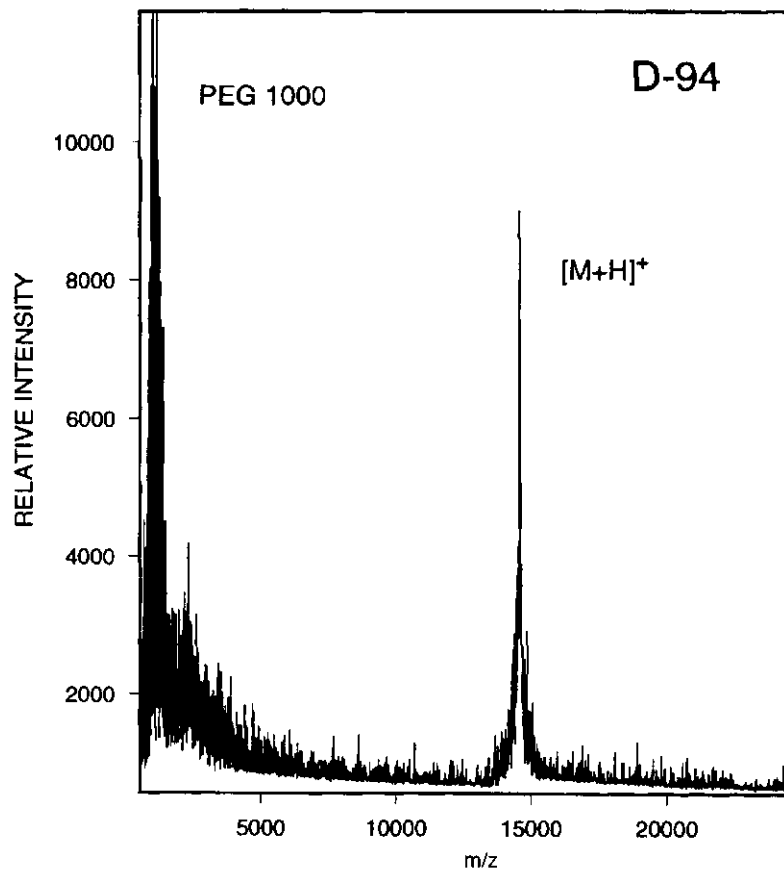

Figure 34.2 The mass spectrum of a substituted fullerene obtained with UV MALDI-FTMS. The mass measurement accuracy was found to agree with that of the proposed structure to within 3.7 ppm, externally calibrated, and the spectral resolution is 10,000.

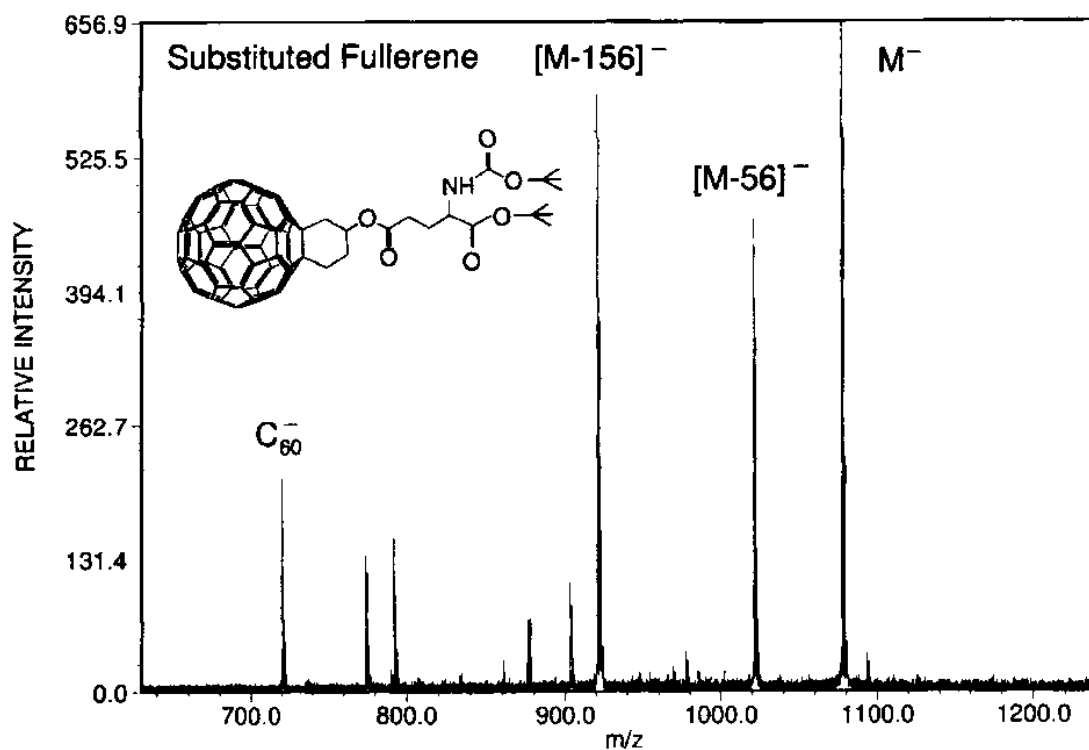
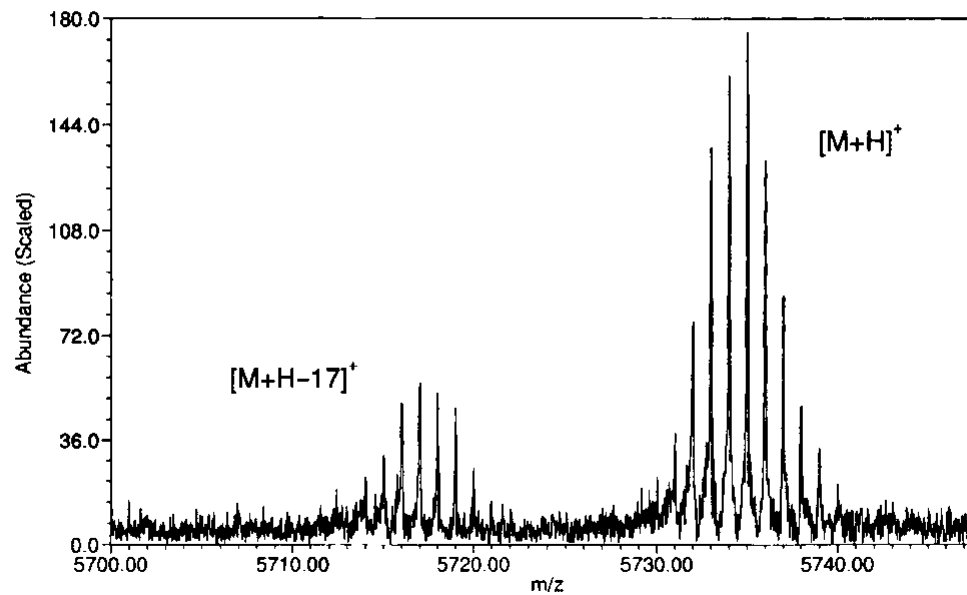
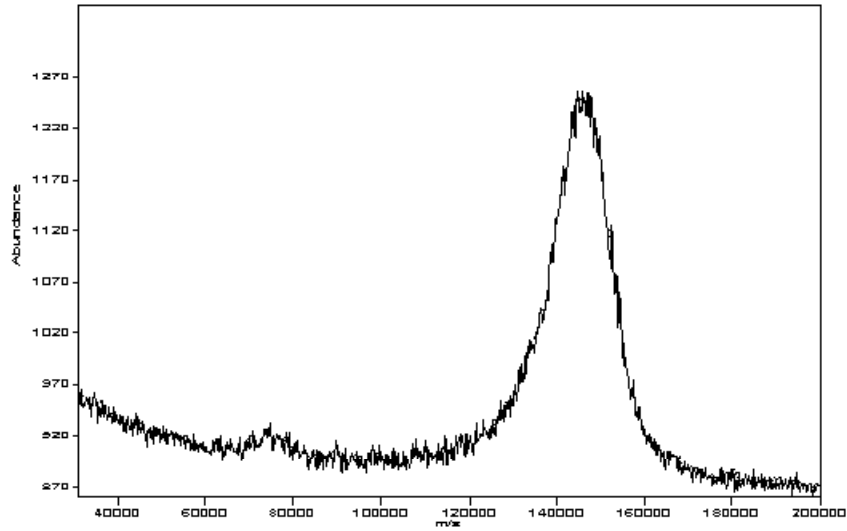
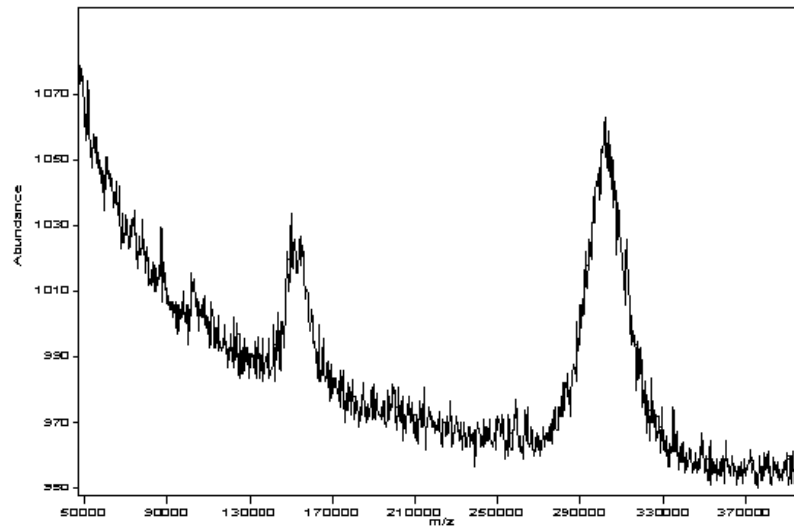

Figure 34.4 A high-resolution UV MALDI-FTMS spectrum of the protein standard bovine insulin. The lower-intensity distribution corresponds to the mass $(M+H)^+ - 17$ Da. The average resolution of the molecular ion peak is 60,000 and the average mass accuracy is 70 ppm, externally calibrated.





MALDI spectrum of polystyrene 145000 distribution



MALDI spectrum of polystyrene 295000 distribution

Immunoglobulin (IgG)

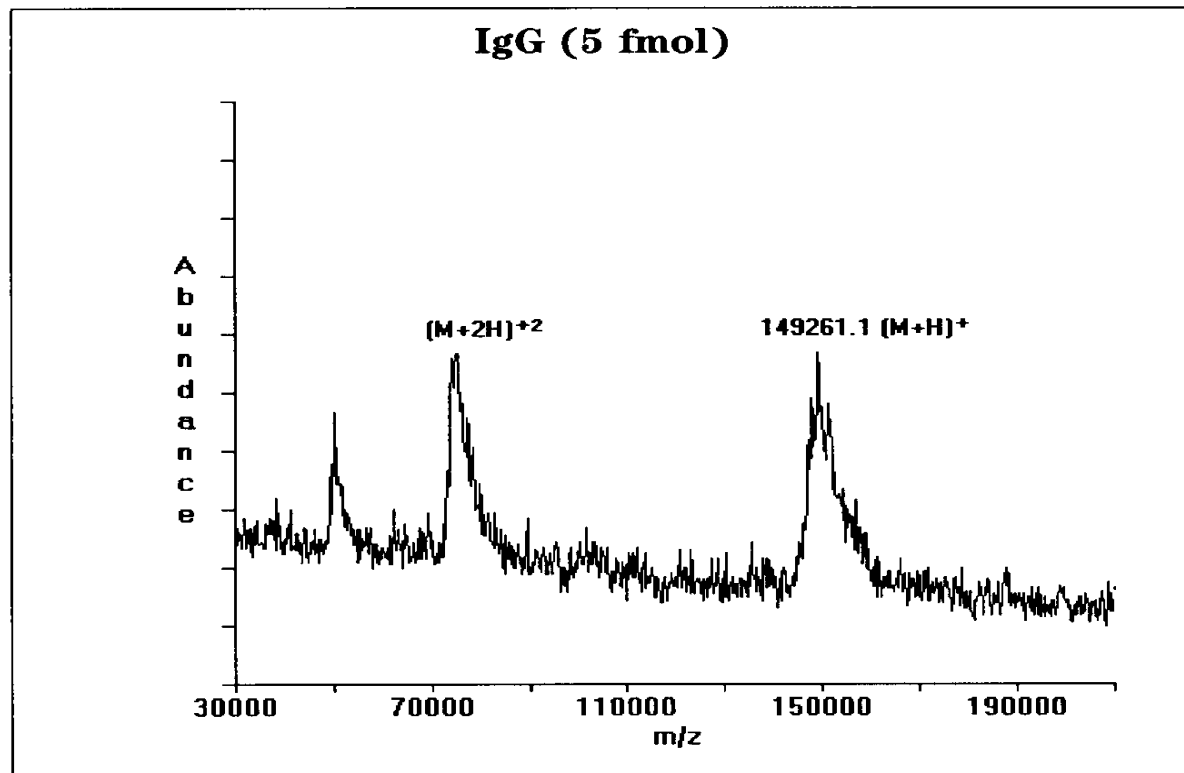

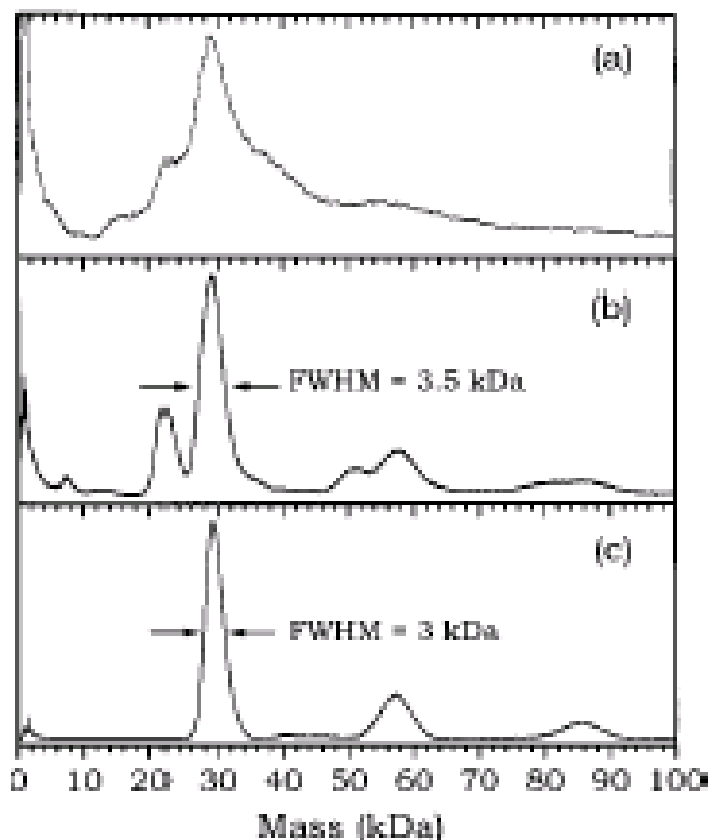

Figure 1. (a) Laser desorption ionization mass spectra from the original, as-prepared, cluster compounds ($R = C_6$). (b) LDI-MS of the mixture after heating in neat dodecanethiol for 18 h and (c) the LDI-MS of the final separated cluster compound that produces ions in the 29 kDa range.

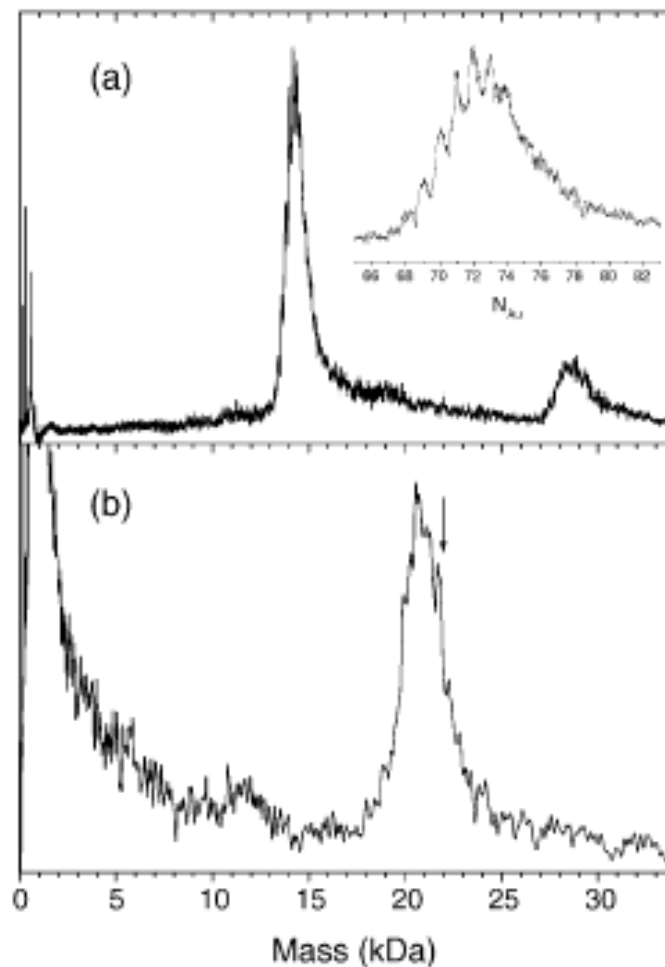

Fig. 3. The negative-ion MALDI mass spectra for Greengold under poor (a) and well (b) co-crystallized conditions [26]. The inset (a) shows an expanded view of the main band, plotted in Au-atom units. The arrow in (b) marks the tentative assignment of the total molecular weight.